

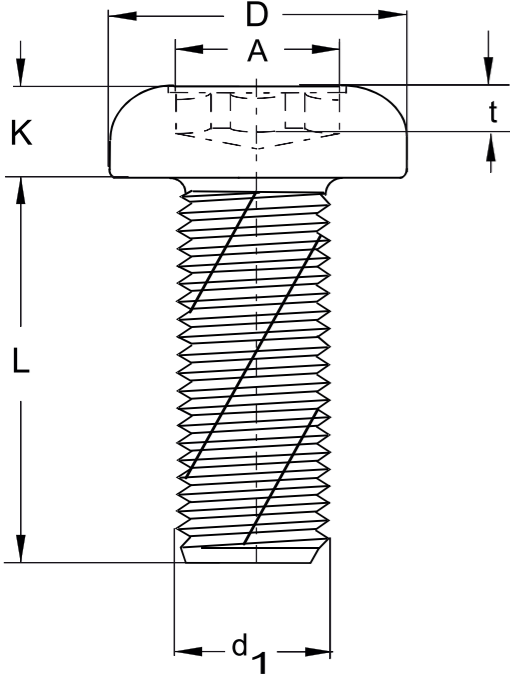

DIN 7500

DIN 7500'e uygun kendi dişini açan metrik vidalar

Self threading metric screws in accordance with DIN 7500

MC - SF 7500 Serisi MC - SF 7500 Series

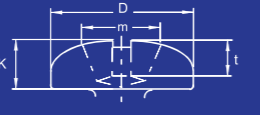
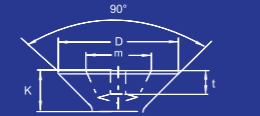
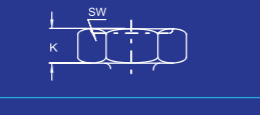

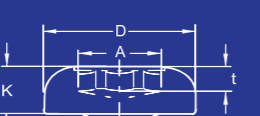
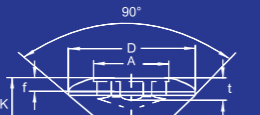
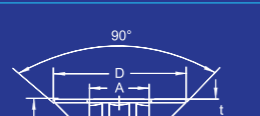
Diş Çapları - Nominal Diameter		MC SF M 2,5	MC SF M 3	MC SF M 3,5	MC SF M 4	MC SF M 5	MC SF M 6	MC SF M 8	
Kafa Formları Head Forms		d1	2,50	3,00	3,50	4,00	5,00	6,00	8,00
DIN 7985		D	5,00	6,00	7,00	8,00	10,00	12,00	16,00
	K	2,00	2,40	2,70	3,10	3,80	4,60	6,00	
	H m/Gr/t min-max	2,7/1/1,30-1,60	3,1/1/1,70-2,00	4,2/2/1,74-2,24	4,6/2/2,04-2,54	5,3/2/2,77-3,27	6,8/3/3,03-3,53	9,0/4/4,18-4,68	
	Z m/Gr/t min-max	2,6/1/1,27-1,52	3,0/1/1,68-1,93	4,0/2/1,65-2,11	4,3/2/1,90-2,36	5,0/2/2,64-3,10	6,7/3/3,02-3,48	8,8/4/4,06-4,52	
DIN 965		D	4,70	5,60	6,50	7,50	9,20	11,00	14,50
	K	1,50	1,65	1,93	2,20	2,50	3,00	4,00	
	H m/Gr/t min-max	2,7/1/1,25-1,55	2,9/1/1,50-1,80	3,9/2/1,40-1,90	4,4/2/1,90-2,40	4,6/2/2,10-2,60	6,6/3/2,80-3,30	8,7/4/3,90-4,40	
	Z m/Gr/t min-max	2,5/1/1,22-1,47	2,8/1/1,48-1,73	3,7/2/1,34-1,80	4,0/2/1,60-2,06	4,4/2/2,05-2,51	6,1/3/2,46-2,92	8,5/4/3,86-4,32	
KF 1346		SW	5,00	5,50	6,00	7,00	8,00	10,00	13,00
	K	1,70	2,00	2,40	2,80	3,50	4,00	5,30	
KF 1347		D			8,00	9,00	11,00	13,00	17,00
	K			3,00	3,40	4,30	5,00	6,60	
	SW			6,00	7,00	8,00	10,00	13,00	
	S			0,80	0,80	1,00	1,20	1,50	
KF 1352		D	5,00	6,00	7,00	8,00	10,00	12,00	16,00
	K	2,00	2,40	2,70	3,10	3,80	4,60	6,00	
	İç 6-Yuvarlak	T8	T10	T15	T20	T25	T30	T40	
	A max / t min-max	2,40/0,90-1,10	2,80/1,00-1,30	3,35/1,20-1,50	3,95/1,40-1,80	4,50/1,60-2,00	5,60/2,00-2,40	6,75/2,70-3,20	
KF 1353		D	4,70	5,60	6,50	7,50	9,20	11,00	14,50
	K	2,10	2,40	2,83	3,20	3,75	4,50	6,00	
	İç 6-Yuvarlak	T8	T10	T15	T20	T25	T30	T40	
	A max / t min-max	2,40/0,90-1,10	2,80/1,00-1,30	3,35/1,20-1,50	3,95/1,40-1,80	4,50/1,60-2,00	5,60/2,00-2,40	6,75/2,70-3,20	
	f ≈	0,60	0,75	0,90	1,00	1,25	1,50	2,00	
KF 1323		D	4,70	5,50	7,30	8,40	9,30	11,30	15,80
	K	1,50	1,65	2,40	2,70	2,85	3,50	4,40	
	İç 6-Yuvarlak	T8	T10	T15	T20	T25	T30	T40	
	A max / t min-max	2,40/0,70-0,90	2,80/0,80-1,05	3,35/0,95-1,20	3,95/1,10-1,45	4,50/1,25-1,60	5,60/1,55-2,00	6,75/1,90-2,40	

Vida Uçları Screw Ends

Form Za Form Ks Form Plus

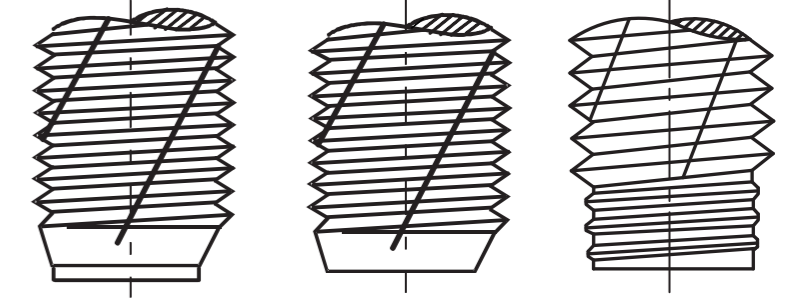

Havşabaş hariç tüm yıldız ve diğer formlar ilave olarak tornavida yarığıyla yapılabilir.
Additional slotted forms available excluding countersunk heads.

Malzeme / Material: 10.9. A2. A4 sementasyon/carburization
Kaplama/ Coating: Her tür mevcuttur.
All kinds available.

Tüm ölçüler mm.'dir. All dimensions in mm.

Yıldız ve Diğer Formlar / Cross-recessed and Other Forms

